



Part of Energy Queensland

Network Standard

Standard for Plant Energisation (STNW1179)

These standards created and made available are for the construction of Energy Queensland infrastructure. These standards ensure meeting of Energy Queensland's requirements. External companies should not use these standards to construct non-Energy Queensland assets.

If this standard is a printed version, to ensure compliance, reference must be made to the Energy Queensland internet site www.energyq.com.au to obtain the latest version.

Approver	Sisira Weeratunga - GM Grid Planning
If RPEQ Sign-off required insert details below.	
Certified Person Name and Position Title	Registration Number
Michael Gorman - Senior Engineer Network Performance	05887

Abstract: This standard details the voltage impact requirements for plant such as transformers, reactors and capacitor banks undergoing energisation on the Ergon Energy or Energex distribution networks.

Keywords: Voltage, Energisation, Transformer, Capacitor Bank, Generator

CONTENTS

1	Overview	4
1.1	Purpose	4
1.2	Scope	4
2	References	5
2.1	Legislation, Regulations, Rules and Codes	5
2.2	Controlled Documents.....	5
2.3	Other Documents	5
3	Definitions and Abbreviations	6
3.1	Definitions	6
3.2	Abbreviations	7
4	Summary of Requirements.....	8
4.1	Measurement and Verification.....	9
4.2	Report Requirements	9
5	Transformer Energisation Inrush	13
5.1	Theory	13
5.2	Harmonic Current Resonances	14
5.3	Sympathetic Interaction.....	14
5.4	System Strength	15
5.5	Collector and Distribution Transformers	15
5.6	Multiple Primary Transformers	15
6	Methodology of Modelling for Transformer Energisation	16
6.1	Numerical Method – Preliminary Studies.....	16
6.2	EMT (Electromagnetic Transient) Modelling.....	16
6.3	Saturation characteristics	17
7	Energisation of Capacitor Banks	18
8	Legislative Requirements	18
8.1	Voltage Fluctuations – National Electricity Rules.....	19
8.2	Voltage Swell Limitations - National Electricity Rules	20
9	Voltage Dip Limitations	20
9.1	Small Generator Shake-Off	21
	Annex A	22
	Informative	22
	Detailed Transformer Energisation Theory.....	22
	Annex B	26
	Normative	26

Numerical Method.....	26
Annex C.....	28
Informative.....	28
Transformer Model Validation Guideline	28
C.1 Model Validation from Inrush Current Measurements.....	28
C.2 Example Model Validation	30
C.3 Consideration of Sympathetic Inrush Current	34
C.4 Model Validation Flowchart	35
C.5 Concluding Note.....	35

FIGURES

Figure 1: Demonstration of Peak Overvoltage.....	11
Figure 2: Demonstration of RMS Line-Neutral Voltages with Worse Case Highlighted.....	12
Figure 3: Inrush current demonstration	12
Figure 4: Inrush Current vs Saturation Curve vs Applied Voltage.....	13
Figure 5: Classical Approach - Transformer Model	17
Figure 6: Percentage Overvoltage Permissible	20
Figure 7: Hysteresis Loop for Magnetism (Electronics Tutorials n.d.).....	22
Figure 8: Inrush Current vs Saturation Curve vs Applied Voltage.....	23
Figure 9: Doubling Effect in a Transformer (Your Electrical Home 2013)	24
Figure 10: Approximate Transformer Model.....	26
Figure 11: Sensitivity of Maximum Inrush Current to Saturation Characteristics for Dyn11 Transformer and Zero Residual Flux.....	30
Figure 12: Transformer Phase Currents as a Function of Switching Angle when Energised Against an Ideal 66kV Source with the Worst Residual Flux.....	31
Figure 13: Transformer Phase Currents as a Function of Switching Angle when Energised Against an Ideal 66kV Source with the Zero Residual Flux.....	31
Figure 14: Measured 66kV Line Current	32
Figure 15: Simulated 66kV Line Current	32
Figure 16: Measured Instantaneous Line to Neutral Voltages	33
Figure 17: Simulated Instantaneous Line to Neutral Voltages	33
Figure 18: Measured 66kV RMS Voltages	33
Figure 19: Simulated 66kV RMS Voltages	34
Figure 20: Model Validation Flowchart	35

TABLES

Table 1: Plant Energisation Acceptance Criteria	8
Table 2: Multiple Energisation Event Limits.....	15
Table 3: List of Assumptions and Challenges Associated with Verification of Factors Affecting Inrush Currents.....	28
Table 4: Model Validation Parameters	29

1 Overview

1.1 Purpose

This standard is to be used to define acceptable voltage impacts of customer electrical plant energisation, to ensure a balance between difficult to meet requirements for proponents and acceptable power quality for all network users.

Transient currents and voltages from energisation activities can lead to power quality issues in terms of non-compliance with the defined acceptable voltage limits, and in extreme cases, produce insulation degradation or surge arrester failure. Exceedance of the high voltage limit can lead to nuisance tripping, equipment damage and failure. Likewise, voltage dips below the acceptable limits may lead to industrial processes malfunctioning, damage to customer equipment or shutting down as well as protection operation.

1.2 Scope

This document details the physics behind energisation inrush, modelling procedure and considerations, and acceptance criteria when authorisation of energisation of a power transformer or other electrical plant onto the Ergon Energy or Energex networks.

It is not intended to cover voltage fluctuations caused by loads or motor starting as examined in AS/NZS 61000.3.7.

It is not intended to be applied retroactively to existing connections where there have been no alterations (alterations such as but not limited to - transformer replacements, transformer additions, contract revisions or addition/replacement of other plant items such as capacitor banks. In these cases application of the current standard shall be required).

1.2.1 Energisation

When electrical plant is energised, the grid will experience a transient phenomenon known as “inrush current”. This is primarily associated with transformers but can also exist for plant such as capacitor filter banks. In a transformer, inrush is caused by the iron core of the transformer reaching saturation due to the abrupt voltage change applied to it and the point on the wave that the transformer energised. When saturated, the transformer absorbs a magnetisation current (i.e. the inrush current), which can reach several times the nominal current of the transformer. This inrush current results in a voltage drop across the source impedance (sometimes commonly called a voltage dip or fluctuation). For a large transformer connecting to a weak grid, unacceptable voltage dips may occur, and therefore must be adequately studied and mitigated. In addition, sympathetic inrush may occur in nearby transformers, causing wider system voltage dip effects, and harmonic resonance induced by energisation may lead to unacceptable overvoltage under certain system conditions.

2 References

2.1 Legislation, Regulations, Rules and Codes

Document	Type
<i>Electricity Act 1994</i> (Qld)	Legislation
Electricity Regulation 2006 (Qld)	Regulation
National Electricity Rules	Rules

2.2 Controlled Documents

Document	Alternative Doc ID
Standard for High Voltage EG Connections - 2946177	STNW1175
Standard for Network Performance - 9997336	
Standard for Sub-transmission and Distribution Planning - 11539388	

2.3 Other Documents

Document Number	Document Name	Document Type
CIGRE 568	Transformer Energization in Power Systems: A Study Guide	Technical Reference
CIGRE 412	Voltage Dip Immunity of Equipment and Installations	Technical Reference
CIGRE 039	Guidelines for representation of network elements when calculating transients	Technical Reference
AS/NZS IEC/TR 61000.2.8	Electromagnetic compatibility (EMC) Part 2.8: Environment—Voltage dips and short interruptions on public electric power supply systems with statistical measurement results	Standard
IEEE 493	IEEE Recommended Practice for the Design of Reliable Industrial and Commercial Power Systems	IEEE Recommended Practice
SA/SNA TR IEC 61000.3.15	Electromagnetic compatibility (EMC) Part 3.15: Limits—Assessment of low frequency electromagnetic immunity and emission requirements for dispersed generation systems in LV network	Standard
AS 60038	Standard Voltages	Standard

61000.3.100	Limits—Steady state voltage limits in public electricity systems	Standard
AS/NZS 4777.2	Grid connection of energy systems via inverters	Standard
AS/NZS 61000.3.7	Limits- Assessment of emission limits for fluctuating loads in MV and HV power systems	Standard
ENA Engineering Recommendation P28	Voltage fluctuations and the connection of disturbing equipment to transmission systems and distribution networks in the United Kingdom	Technical Reference

3 Definitions and Abbreviations

3.1 Definitions

For the purposes of this standard, the following definitions apply.

acceptable model	a site-specific model which follows the requirements of AEMO’s Power System Model Guidelines.
committed	<ul style="list-style-type: none"> • AEMO has issued a letter to the connecting NSP under clause 5.3.4A of the NER indicating that AEMO is satisfied that each specified access standard meets the requirements applicable to a negotiated access standard under the NER; • an offer to connect has been issued by the Connecting NSP in accordance with clause 5.3.6 of the NER; • AEMO and the connecting NSP for that other proposed connection have accepted a detailed PSCAD™/EMTDC™ model provided by or on behalf of the Connection Applicant of that proposed connection meets the requirements of the Power System Model Guidelines; • any proposed system strength remediation schemes or system strength connection works in respect of that other proposed connection have been agreed between the relevant parties, or determined by a dispute resolution panel; and • there is no reasonable basis to conclude that the model previously provided is materially inaccurate, including following commissioning of the connection.
Detailed response to enquiry	a detailed, in-depth analysis and considerations for the particular proposed project and enabling the proponent to move towards submitting an Application to Connect.
collector transformer	In a renewable generation plant, inverter units aggregate up to a low voltage: medium voltage transformer, as an example, 550V to 33kV.
electrically close	up to 200km away as measured through the electrical system.

generator	Has the meaning given in the NER. Broadly this is a person who engages in the activity of owning, controlling or operating a generating system that is connected to and/or supplies electricity to Ergon Energy's or Energex's distribution network.
micro EG	Refers to a generating system with generating units of the kind contemplated by AS 4777 as per 5A.A.1 of the NER.

3.2 Abbreviations

This list does not include well-known unambiguous abbreviations, or abbreviations defined at their first occurrence within the text.

AC	Alternating Current
AEMC	Australian Energy Market Commission
AEMO	Australian Energy Market Operator
AVR	Automatic Voltage Regulation
CB	Circuit Breaker
CBF	Circuit Breaker Fail
CBD	Central Business District
DC	Direct Current
EG	Embedded generator/ generating unit
EMT	Electromagnetic transient
FCAS	Frequency Control Ancillary Service
GPR	Grid Protection Relay
GPS	Generator Performance Standard
HV	High voltage. A voltage exceeding 1,000 V AC and 1,500 V DC.
IES	Inverter Energy Systems
LDC	Line drop compensation
LV	Low voltage. A voltage not exceeding 1,000 V AC or 1,500 V DC.
MEGU	Micro-embedded generating unit
NCP	Network Coupling Point
NER	National Electricity Rules
OH	Overhead conductor, "lines"
POE10	Forecasting; 10% Probability of Exceedance

PSCAD™/EMTDC™	Refers to a software package developed by the Manitoba-HVDC Research Centre that comprises a power systems computer-aided design package which includes an electromagnetic transients (including DC) simulation engine, and which is used to carry out electromagnetic transient type studies.
p.u.	Per unit
RMS	Root-mean square
ROCOF	Rate of change of frequency
RPEQ	Registered Professional Engineer of Queensland
SACS	Substation Automated Control System
SCR	Short Circuit Ratio
UG	Underground conductor, “cables”
VVR	Volt Var Regulation
VT	Voltage transformer
ZS	Zone Substation

4 Summary of Requirements

The maximum acceptable voltage drop or overvoltage effect on energisation of either a single transformer, or all plant behind a single connection point simultaneously, is shown in Table 1:

Table 1: Plant Energisation Acceptance Criteria

All Connections ¹
<ul style="list-style-type: none"> • RMS Voltage dip or overvoltage spike remains within 0.9pu to 1.1pu • The voltage returns to 95% of pre-disturbance rms voltage within 200ms •

Facilities comprising more than one transformer, such as an additional primary grid connection transformer, or multiple collection or distribution transformers, where they cannot be energised simultaneously to the primary transformer, either due to practical reasons or because such an energisation would non-compliant with Table 1 requirements, shall adhere to the criteria defined in Section 5.5.

¹ 11kV, 22kV and 33kV connected generating systems may not have a grid connection power transformer but will have step-down transformers associated with the collector network systems. These transformers may also cause inrush effects and so must be studied. Additionally, these systems may have harmonic filters installed. Likewise, some load connections may have distribution transformers located on their premise to meet site needs.

4.1 Measurement and Verification

For all large customers, a power quality meter (primarily for the purposes of harmonic and flicker compliance) shall be installed at the appropriate location as close to the point of connection as practicable, noting the connection arrangement of VTs so that any energisation event can be recorded and reviewed.

4.2 Report Requirements

A plant energisation report is to be provided at the application stage to demonstrate compliance with Table 1. This may cover primary transformers, distribution and/or collector transformers, harmonic filters, or other electrical plant as relevant. It is not intended to include analysis of voltage fluctuation caused by repeated processes such as drilling or pumping.

Ergon Energy and Energex expect methodology consistent with industry standards listed in the Reference section.

The following aspects shall be represented:

- Leakage impedance and winding resistance;
- Nonlinear saturation and core losses (Air-core inductance);
- Magnetic phase coupling;
- Residual flux in transformer cores;
- Appropriate consideration and representation of Zero Sequence Impedance for the transformer;
- Hysteresis and frequency dependent iron losses.

The report shall detail:

- Description and extent of the network modelled;
- Assumptions made;
- System normal, minimum system strength and contingency (N-1) scenarios in the upstream network that represent worst case with discussion in the report as to why these are considered worst case;
- Consideration of sympathetic inrush in other transformers or capacitors in the network;
- Consideration of harmonic resonance;
- Details of the BH curve used for the transformer(s); where a BH curve is not available or not yet available, appropriate literature supported assumption on suitable approximations for BH curve should be used.
- Capacitance information of capacitor banks, including power factor correction equipment, with any inrush reactors if relevant;
- Energisation of capacitor bank or harmonic filters, if present;
- Where the transformer is for a site comprising a number of downstream transformers, such as collector feeder transformers for solar farms or distribution transformers for site loads, inclusion of energisation of these transformers and a comparison of individual energisation or all being energised at once, including sympathetic effects;

- Where there are two or more primary transformers, consideration of energisation at once or individually;

Results showing the following profiles and differences for each of the scenarios with extended tails up to 7 seconds if required (preferably in a table format):

- 50 Hz voltage
- Individual peak phase voltage (under- or -over-voltage, as applicable)
- Peak individual phase inrush and instantaneous currents
- RMS voltage drop for individual line-to-neutral voltages and line-to-line voltages
- 50Hz levels/peak voltage/RMS step for the worst phase represented as a table
- A table which clearly states the buses studied, the pre-energisation voltage (including, the minimum allowable pre-energisation voltage), the maximum individual phase line to ground voltage dip, and the maximum transient current and period of time before the connection point voltage returns to 95% of pre-energisation and then to the pre-energisation voltage; and
- A graph that clearly displays the RMS Percentage of Voltage over time from energisation of transformer to the time it takes to return within 1% of the pre-disturbance voltage.

Compliance with the criteria in Table 1 shall be assessed on line-neutral RMS voltage for each phase. Provision of peak phase voltages is nevertheless required.

The conclusion of the studies in comparison with this standard. Where the studies identify that the standard is not met without mitigation, then the report shall detail remediation considered and recommended for the location and the modelled effectiveness and subsequent compliance with this standard, such as provision for transformer design, point on wave switching, pre-insertion resistors, or other risk mitigation measures. This may include specification of an energisation procedure to achieve compliance which will subsequently be recorded in the operating protocol. Proponents may opt to propose a mitigation measure, such as point on wave switching from the outset, however this does not remove the requirement to undertake studies to demonstrate that the proposed mitigation will be effective and result in compliant energisation.

4.2.1 Clarification of Reference Parameters

For the avoidance of doubt, the below figures clarify assessment criteria. Figure 1 demonstrates the peak overvoltage resulting from an energisation event for a 132kV nominal system where an overvoltage event, due to harmonic resonance, occurs upon energisation. The peak waveform is the highest peak value of the three phase voltages (whether positive or negative peak values). Therefore the absolute values of the voltage waveforms are calculated, and then compared to give the maximum from all three phases over the applicable study period.

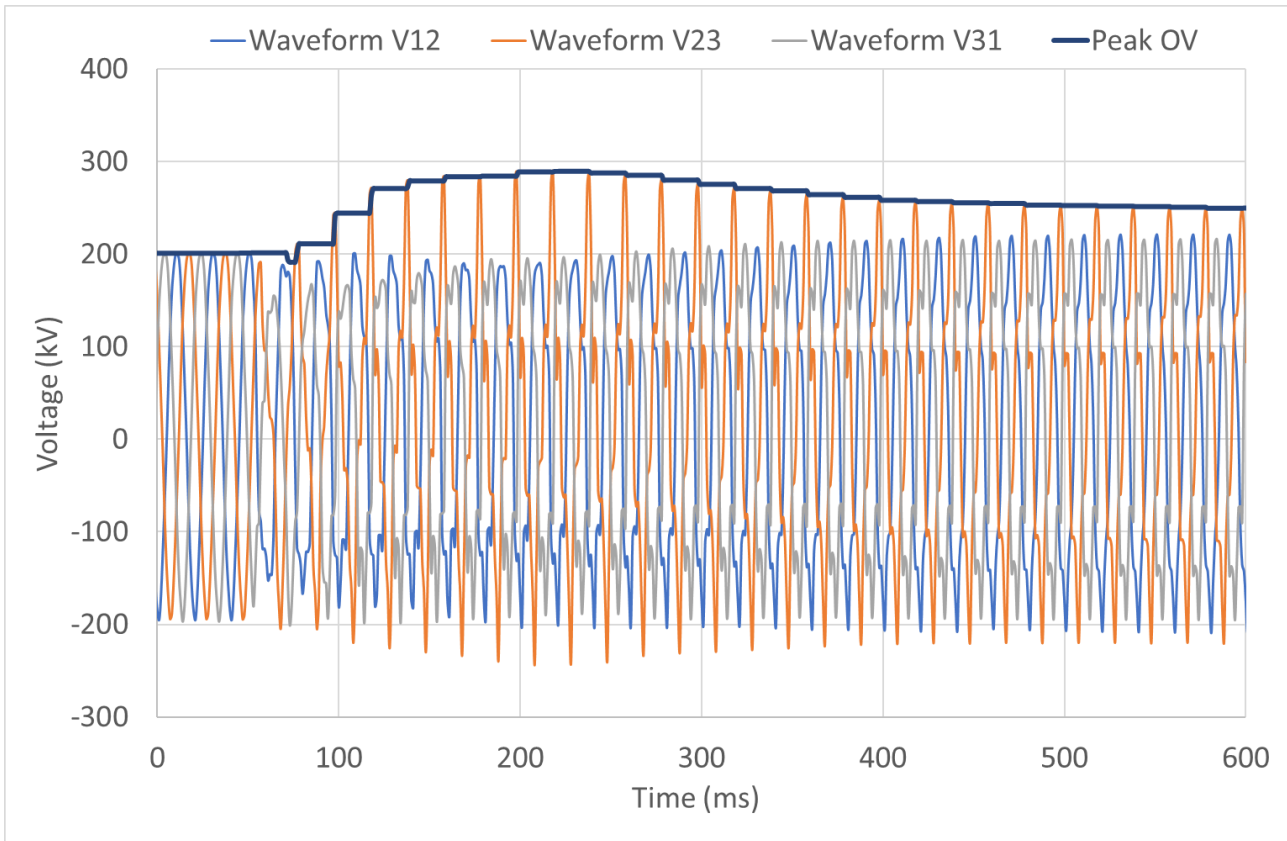

Figure 1: Demonstration of Peak Overvoltage

Figure 2 shows an example of line-neutral RMS voltages, with the worse phase dip shown, and the recovery period to 95%, and 99% of the pre-disturbance voltage. The peak is also shown, for completeness. In this case, the pre-disturbance voltage was 1.06p.u., hence 95% and 99% representing 1.01 and 1.05 respectively.

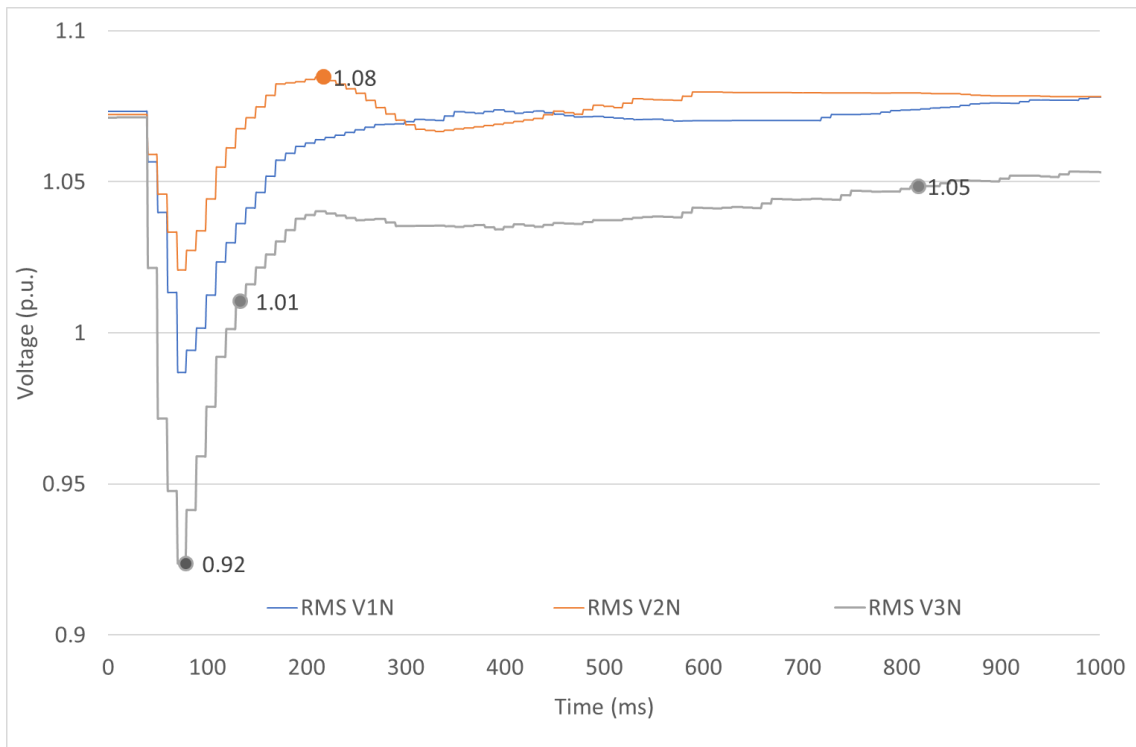

Figure 2: Demonstration of RMS Line-Neutral Voltages with Worse Case Highlighted

Figure 3 shows the peak inrush current and subsequent decay.

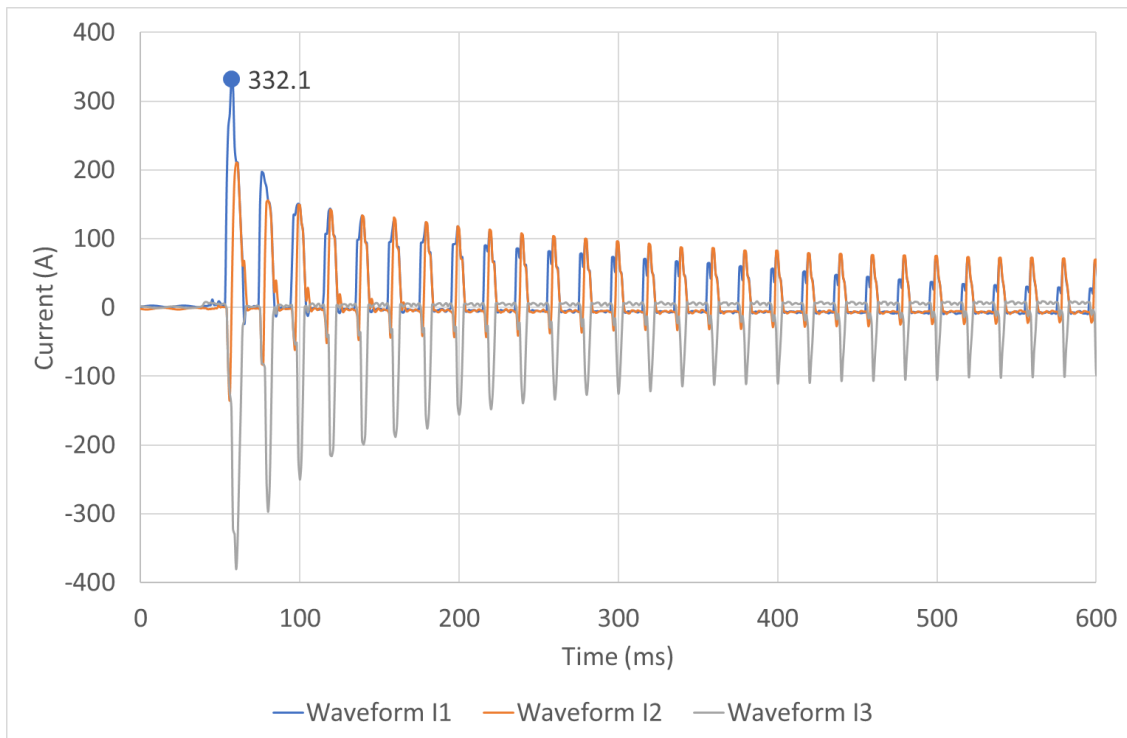

Figure 3: Inrush current demonstration

5 Transformer Energisation Inrush

5.1 Theory

Power transformer inrush current is a phenomenon that occurs when a transformer core becomes saturated. This can be caused by switching transients, out-of-phase synchronisation of a generator, external faults, fault clearance or energisation. The most severe case is when a transformer is initially energised by applying a voltage, switching at voltage zero crossing for one phase, whilst the transformer core holds a residual flux, where the flux in the core can reach a maximum two times the rated peak flux plus the residual flux offset.

Residual flux is the flux that remains after a transformer has been de-energised whilst still holding some degree of magnetism. The current is determined by the flux-linkage, which is calculated as the time-integral of the voltage applied to the transformer. The initial value of the flux-linkage is determined by the residual flux in the transformer core prior to energisation. The flux-linkage/current relationship is nonlinear and is determined by the saturation curve of the transformer. This is represented in Figure 4.

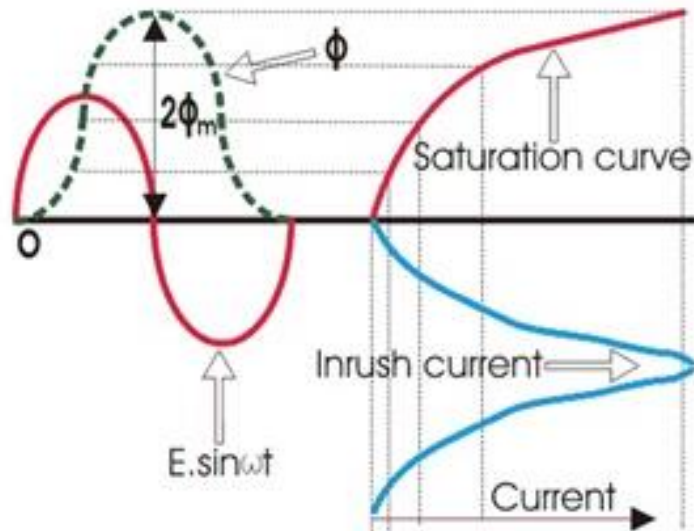

Figure 4: Inrush Current vs Saturation Curve vs Applied Voltage²

The main factors affecting the inrush current magnitudes can be categorised as: transformer design, initial conditions, and network factors.

The design of a transformer can affect the magnitude of the inrush current as it can shift the steady state operating point on the saturation curve. A transformer with an operation point closer to the knee area of the saturation curve is easily brought into saturation.

Initial conditions affecting the magnitude of inrush current are residual flux and the point-on-wave (POW) energisation. These influence the magnitude of inrush currents and affect the DC offset of the flux-linkage and the saturation of the transformer. The residual flux is the flux that remains trapped in the core due to a previous de-energisation of the transformer and defines the initial DC offset of the flux in the core. Energisation at a voltage zero crossing results in the most severe inrush

² Source: Electrical 4 U

current for a transformer as it induces a flux-linkage of theoretically up to 2 p.u. (with 1 p.u. DC offset); the residual flux adds on top of that giving a maximum possible flux-linkage of almost 3 p.u.

Energising a transformer at voltage peak results in no DC offset other than that caused by the initial residual flux³.

High network impedance acts as a limiting factor for inrush current as the high inrush current causes a voltage drop at the transformer terminals which limits the saturation of the transformer.

Transformer energisation is covered in more detail in Annex A below.

5.2 Harmonic Current Resonances

Transformer saturation is a highly nonlinear phenomenon with inrush current containing harmonic and DC components besides the fundamental component. To obtain the magnitude and phase shift of each harmonic component, a Fourier analysis should be conducted for each cycle of the inrush current separately. In some cases the duration of the harmonic components can attain their maximum value a few cycles after energisation, or experience a phase shift as the magnitude of the harmonic passes through zero. If the harmonic currents coincide with a parallel resonance in the frequency dependent impedance of the network it can result in overvoltages which can cause damage to plant and equipment. This can also cause wider operational problems in the network for other network users, including protection mal-operation where the protection scheme has not been designed to account for energisation phenomenon and currents with rich harmonic content. The maximum overvoltage often occurs during the decay of the inrush current and not immediately after energisation, when the individual harmonics attain their maximum values.

The spectrum of harmonic currents cannot be generalised as it depends highly on the power system harmonic characteristics, transformer nonlinearities and the initialisation conditions. Therefore a case-by-case study is required for each specific transformer. The harmonics are generally low order, peaking at the second harmonic. An impedance scan looking into the network might indicate whether there is a risk of transformer inrush current exciting harmonic overvoltage (for example if a parallel resonance resides below ~7th harmonic).

5.3 Sympathetic Interaction

Sympathetic interaction can occur when a transformer or shunt reactor is energised onto a system with long transmission lines in the presence of other electrically close and energised transformers or shunt reactors. This can significantly change the duration and the magnitude of the transient magnetising currents in the transformers involved. Shunt reactors present a lower risk because they typically have air gaps in the iron core that do not significantly saturate and will have a reasonably linear behaviour during energisation.

Transformers are typically energised in series or in parallel with other transformers already in service. On systems with appreciable series resistance, this inrush transient may trigger a transient interaction between the transformer being energised and those already in operation. This may lead to protection maloperation due to induced inrush currents or influence of harmonic currents on relays without harmonic restraint. This occurs because the existing transformers go into saturation, produced by asymmetrical voltage waveforms at the busbar due to the asymmetrical voltage drop across the series resistance of the system caused by the inrush current. Hence, sympathetic interaction shall be considered as part of the transformer energisation study.

³ Refer to Cigre 568 for additional information

5.4 System Strength

System strength also has an impact on the effect of energisation. Systems with high system strength will experience less voltage dip than systems with lower system strength as there is less impedance in the system and therefore reduced voltage drop.

5.5 Collector and Distribution Transformers

Renewable energy generators generally have a large grid-connection power transformer, and then a number of collector feeders, where output from a number of inverters or turbines are aggregated. Likewise, some load customers have a number of distribution transformers to supply areas of their facility. A transformer is required to step-up or step-down the upstream voltage (usually 11kV, 22kV or 33kV). Often these collector or distribution transformers are small (typically 2.5-6 MVA) and may have a different copper/steel mix to larger power transformers. This can affect the energisation behaviour of the transformers and the knee-point of saturation. As such, the impact of a 5 MVA transformer at 11kV can be similar to a larger power transformer at higher voltage levels. Therefore, this must also be studied, and the resultant voltage dip considered in the context of acceptable voltage fluctuations, as the energisation will be repeated over a day (or longer) until all the transformers are energised. Sympathetic inrush as subsequent transformers are energised shall also be considered.

The following table is provided as guidance in relation to voltage dips associated with numerous energisation events.

Table 2: Multiple Energisation Event Limits

Events (r) per hour	Change in Voltage on Energisation (%)	
	MV ($\leq 66\text{kV}$)	HV ($>66\text{kV}$)
$r \leq 1$	$4 \leq \Delta V < 5$	$3 \leq \Delta V < 4$
$1 < r \leq 10$	$3 \leq \Delta V < 4$	$2.5 \leq \Delta V < 3$
$10 < r \leq 100$	$2 \leq \Delta V < 3$	$1.5 \leq \Delta V < 2.5$
$100 < r \leq 1000$	$1.25 \leq \Delta V < 2$	$1 \leq \Delta V < 1.5$

Energisation of distribution or collector transformers may commence on the same day as the primary transformer, where applicable limits can be met.

5.6 Multiple Primary Transformers

Some sites may have two or more primary grid connection transformers. In this case, it shall be assessed whether the transformers can be energised together, or whether a number of energisation events are required. Transformers can be energised together where the total impact is within the limits of Table 1. If the site cannot comply, multiple energisation events can be considered as part of the mitigation. Where multiple events are required, compliance shall be phased over subsequent days, or may be considered in terms of Section 5.5 where supported with sufficient modelling.

6 Methodology of Modelling for Transformer Energisation

Numerical Methods and electromagnetic-transient methods can be used for modelling of the effects of transformer energisation including identifying peak inrush current, maximum voltage dips, and current and voltage recovery times.

6.1 Numerical Method – Preliminary Studies

Numerical Methods can only accurately be used to estimate single phase system inrush currents, voltage dips and recovery times. The reason for this is the complexity required to estimate a three-phase system which would need to include the interaction of multiple coils and the residual flux interacting with each of the three phases. Adding to this, independent switching of the circuit breaker poles will then introduce further complexity with regards to massive negative sequence currents arising as a result of the individual switching of the phases.

One numerical method has been detailed in Annex B of this Standard. Industry papers, such as ENA ER P28, Cigre 568 and others, also detail numerical methods of energisation.

Numerical methods should only be used to gauge general risk of a transformer energisation and should not be used as a basis for design.

6.2 EMT (Electromagnetic Transient) Modelling

Energisation of the transformer can also be modelled using PSCAD/EMTDC or equivalent EMT software. A network model must be built, and the transformer model created. This network model must be sufficient to assess the impact to other connected customers; for example, the model extent and methodology should allow for assessment of voltage dips at connection points for other customers in the vicinity of the transformer being studied, possible sympathetic inrush in nearby transformers and harmonic overvoltages during the inrush transient.

Transformer core saturation should be modelled with careful consideration given to assigning values to parameters where test or theoretical data is unavailable. There are two main methods by which transformers are modelled in PSCAD; the Classical Approach and the Unified Magnetic Equivalent Circuit (UMEC) method. The classical models are limited to single phase units where the different windings are on the same leg of the core, while the UMEC models consider the core geometry and represent inter-phase coupling.

The primary difference between these two models relates to how core non-linearity is represented. In the Classical models, the non-linear characteristics are approximated based on the knee point, air core reactance and magnetising current at rated voltage; core saturation is modelled using a compensating current source across the winding closest to the core. The UMEC model requires the non-linear core characteristics to be entered directly as a piece-wise linear V-I (rms) curve.

The more sophisticated saturation models suffer from the disadvantage that in most practical situations, the data is not available to make use of them, e.g. the saturation curve is rarely known much beyond the knee, and detailed transformer design data such as core and winding dimensions may not be available.

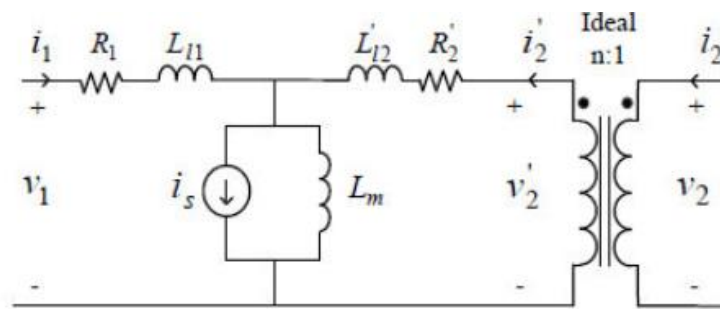

Figure 5: Classical Approach - Transformer Model⁴

This modelling should consider the theoretical worst-case conditions, in order to determine the worst-case scenario. For example, the studies should consider minimum system fault levels, a worst case point on wave switching event⁵ where the POW timing is off-target by $\pm x$ ms (as determined through analysis) and worst case theoretical residual flux in the transformer cores. Where assumptions are made, the studies should demonstrate the sensitivity of the assumption (e.g. for an assumed air core reactance, studies should show the sensitivity in results when varying the air core reactance within the typical range).

The following aspects need to be represented in the EMT model:

- Leakage impedance and winding resistance;
- Nonlinear saturation and core losses (Air-core reactance);
- Magnetic phase coupling;
- Residual flux in transformer cores;
- Appropriate consideration and representation of zero sequence impedance for transformer type;
- Hysteresis and frequency dependent iron losses

All generation proponents, or load customers with (a) large transformer(s) shall submit the results of the EMT transformer energisation study at the Application to Connect stage.

6.3 Saturation characteristics

Where the nonlinear saturation and core losses are not known, the following assumptions, detailed in CIGRE Technical Brochure 039⁶, can be made:

- | | |
|--|---|
| • step-down transformer (HV side, outer winding) | $X_{AIR} \approx 2 \text{ to } 2.5 X_L$ |
| • step-up transformer (LV side, inner winding) | $X_{AIR} \approx 1 \text{ to } 1.5 X_L$ |
| • autotransformer (high voltage side) | $X_{AIR} \approx 4 \text{ to } 5 X_L$ |

⁴ Source - <https://www.pscad.com/>

⁵ Where point-on-wave switching is proposed as a mitigation method

⁶ CIGRE, "Guidelines for representation of network elements when calculating transients", Technical Brochure 039, WG 33.02, 1990.

7 Energisation of Capacitor Banks

When a capacitor bank is energised, inrush current and overvoltages can result. The total inrush current combines the steady state load current of the capacitor bank, with the inrush from the system, as well as any sympathetic inrush from adjacent banks.

The inrush current can be represented by:

$$I_{peak} = \frac{V_{peak}}{Z_C}$$

$$Z_C = \sqrt{\frac{L}{C}}$$

$$f = \frac{1}{2 \cdot \pi \sqrt{LC}}$$

Where:

I_{peak} peak inrush current;

V_{peak} peak voltage;

f transient frequency.

In addition, the inrush from the system, and the sympathetic inrush from adjacent banks must be included.

This large inrush current can result in a significant voltage dip. One method of mitigation of these inrush current is with the installation of an inrush reactor.

Immediately following the voltage dip, the system voltage will attempt to recover, but will over-shoot the normal system voltage by an amount that is nearly equal to the voltage dip. Theoretically, two per-unit over-voltages can occur due to capacitor switching.

A report detailing the energisation effect of a capacitor bank shall include:

- Parameters and design of the capacitor bank,
- Internal network of the plant,
- Considerations of sympathetic inrush from nearby capacitor banks,
- Effect of transformer tapping,
- Consideration for harmonics,
- Voltage impacts on the wider network.

8 Legislative Requirements

Voltage regulation in Queensland is defined by the Queensland Electricity Regulation.

For a low-voltage system, 11(4) of the Regulation defines the standard voltage as the nominal voltage as stated in AS60038. 13(3)(a) and (b) specifies that changes of voltage at a customer's terminals, 'does not differ from the standard voltage by more than the percentage stated for the supply voltage range in AS60038; or otherwise is within the minimum preferred steady state median voltage and the maximum preferred steady state median voltage stated in AS 61000.'

For a supply at high voltage, clause 12 of the Regulation states that the agreed voltage is the standard voltage for supply, and 13(4) defines that for voltages of 22,000V or less, the high voltage is to be maintained at no more than 5% more or less than the standard voltage, while for voltages more than 22,000V, within an agreed margin.

For both scenarios, the methodology for measurement of steady state voltage stated in AS61000 (i.e. 61000.3.100) applies.

This gives a probabilistic limitation for transient events, rather than a fixed deterministic requirement.

8.1 Voltage Fluctuations – National Electricity Rules

At present, in Queensland, derogation 9.37.12 applies with reference to voltage fluctuation, replacing clause S5.1.5.

“A Network Service Provider whose network is a Queensland transmission network or a Queensland distribution network must ensure that voltage fluctuations caused by the switching or operation of network plant does not exceed the following amounts referenced to Figure 1 of Australian Standard AS 2279, Part 4:

- 1) Above 66kV:
 - a) the "Threshold of Perceptibility" when all network plant is in service; and
 - b) the "Threshold of Irritability" during any credible contingency event which is reasonably expected to be of short duration;
- 2) 66kV and below: the "Threshold of Irritability" when all network plant is in service.

The requirements of paragraphs (1) and (2) above do not apply to events such as switching of network plant to or from an abnormal state or to network faults which occur infrequently (i.e. less than one event per day).

Each Customer must ensure that variations in current at each of its connection points including those arising from the energisation, de-energisation or operation of any plant within or supplied from the Customer's substation are such that the contribution to the magnitude and rate of occurrence of the resulting voltage disturbance does not exceed the following limits:

- (i) where only one Customer has a connection point associated with the point of supply, the limit is 80% of the threshold of perceptibility set out in Figure 1 of Australian Standard AS2279, Part 4; or
- (ii) where two or more Distribution Network Service Providers or Customers causing voltage fluctuations have a connection point associated with a point of supply, the threshold of perceptibility limit is to be shared in a manner to be agreed between the Distribution Network Service Provider and the Registered Participant in accordance with good electricity industry practice that recognises the number of Registered Participants in the vicinity that may produce voltage fluctuations.”

The derogation clearly calls out Figure 1 from AS2279.4 and not the standard itself which is in fact obsolete. It is important for a generator customer, connecting under 5.3A of the National Electricity Rules to ensure they comply with the requirements of S5.2.5.2 for their connection. This must be in harmony with the derogation 9.37.12. However it is recognised that some consideration of frequency and impact to other customer connections may need to be taken which this standard addresses.

8.2 Voltage Swell Limitations - National Electricity Rules

A voltage swell is a temporary increase of the voltage at a point in the electrical system above 14% of the nominal voltage. Voltage swells are described by duration and maximum voltage. They may last from half a cycle to 60 seconds. If the voltage continues to be greater than 10% after 60 seconds, it is defined as Overvoltage. Overvoltage should be read in conjunction with Voltage Swell. For Energy Queensland, the limit for voltage swells is defined by Figure S5.1a.1 of the National Electricity Rules (NER):

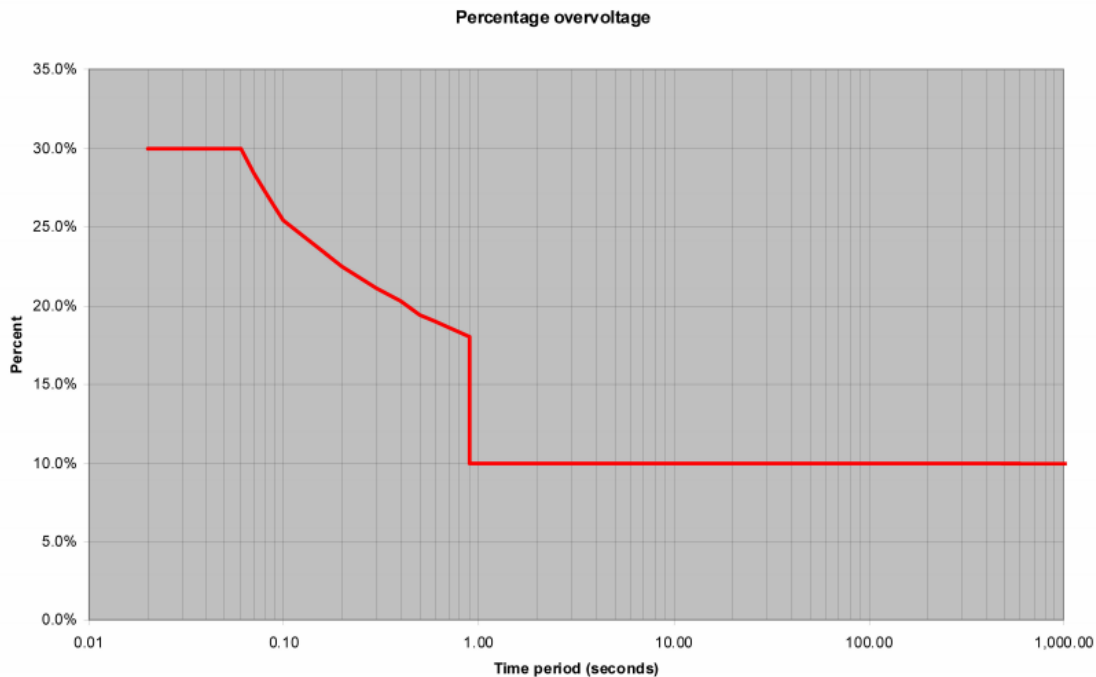

Figure 6: Percentage Overvoltage Permissible

9 Voltage Dip Limitations

Voltage dips, or sags, are short-duration reductions in voltage magnitude. These dips can have an impact on end-use equipment. Industrial processes may malfunction or shut down due to a voltage dip, resulting in financial losses or equipment damage. As such, it is a requirement that network service providers keep voltages within certain limits as described in the Queensland Electricity Regulation.

Equipment withstand capability is subject to a number of standards, particularly IEEE 493 and SA/SNA TR IEC 61000.3.15. Withstand capabilities for transients are not well-defined.

Equipment immunity is affected by both the voltage related parameters such as pre-disturbance voltage magnitude, dip duration, dip magnitude and the post-dip recovery, as well as specific hardware parameters and the load type. As such, criteria for acceptability must include reference to both the magnitude of a dip, as well as the duration.

Transformer energisation is an aperiodic event- that is, once it occurs, it is not expected to occur again for some time. Hence, typical methods of measuring flicker are not applicable.

Given the size and diversity of the Ergon Energy and Energex networks, it must be assumed that not all devices connected comply with equipment withstand standards. There are numerous synchronous and asynchronous motors that are connected to the network. AS61000.2.8 identifies

that asynchronous motors are generally tolerant to residual voltage of 70% of rated voltage, while synchronous motors may only be tolerant to 75%.

Generators likewise are affected by voltage dips. Generators fall in to two categories:

- Smaller systems, which do not maintain operation during a dip scenario (typically LV connected) as detailed in section 10.1 below
- Larger systems, which have low-voltage ride through capability of residual voltage of 70%-80% for two seconds

For systems with low-voltage ride through capability, a voltage dip event such as a result of transformer energisation forces the generator into ride-through mode. This causes the generator to vary its normal response. While this is expected to occur during genuine faults, to deliberately cause such a fault response is seen as ‘causing harm’ and must be avoided.

9.1 Small Generator Shake-Off

Small generating systems compliant with AS4777.2:2015 have an undervoltage protection function for anti-islanding reasons and will trip after 1s at 180V (0.78p.u. for 230V nominal). This was amended to 10s below 180V (0.78pu), and 1s below 70V (0.3p.u. for 230V nominal) with the amended AS/NZS4777.2:2020. As penetration of small generation increases, generator “shake-off” presents a risk to power system security⁷.

⁷ Refer [AEMO Renewable Integration Study](#)

Annex A

Informative

Detailed Transformer Energisation Theory

Power transformer inrush current is a phenomenon that occurs when a transformer is initially energised by applying a voltage whilst the transformer core holds a residual flux/magnetism⁸. Residual flux is the flux that remains after a transformer has been de-energised whilst still holding some degree of Magnetism (denoted by the unit B (Tesla)). An example of this is by looking at the hysteresis curve in Figure 7.

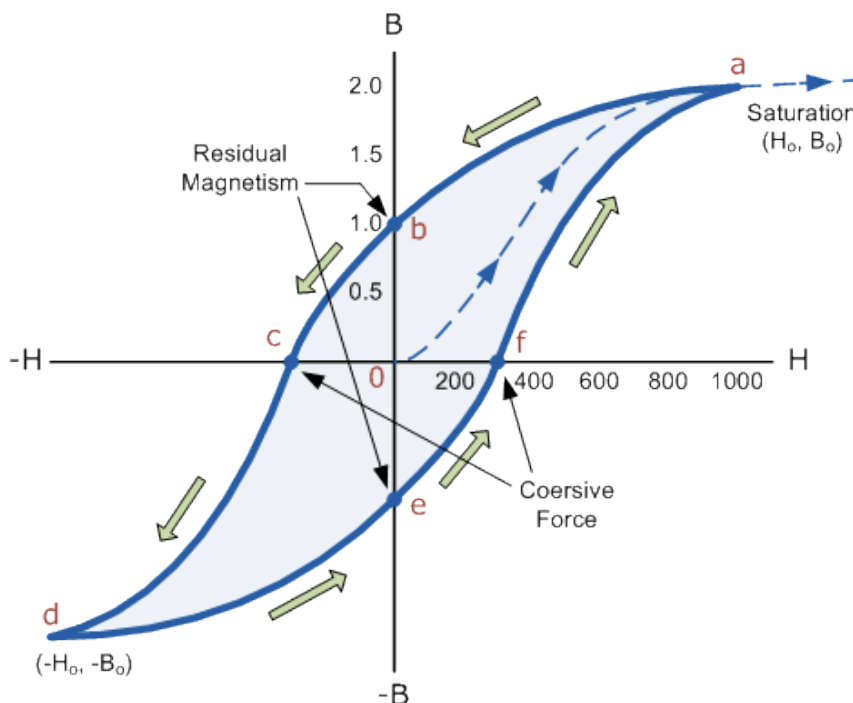

Figure 7: Hysteresis Loop for Magnetism (Electronics Tutorials n.d.)⁹

The arrows in Figure 7 represent a sinusoidal voltage waveform. The Y-intercept of this figure represents an angle of 0° in the waveform. If the transformer is de-energised with the voltage waveform at 0°, a residual flux or magnetism will be held in the transformer. This is due to the alignment of the dipole molecules in the metal core, which will always align their polarity in the direction of magnetic fields. For simplicity, only the main loop has been shown here, other resultant minor B-H loops have not been included.

In essence, an external force (or 'coercive force') must be applied on these dipole molecules in order to force their positioning/alignment into a random order that results in the cancellation of the magnetic

⁸ It is noted that inrush current will occur regardless of the residual flux, it is the outcome which worsens depending on the value and sign of the residual flux

⁹ <https://www.electronics-tutorials.ws/electromagnetism/magnetic-hysteresis.html>

fields they create, as opposed to the strengthening of the magnetic field. If the correct coercive force is not applied to the transformer core, the core will hold a residual flux after its de-energisation.

This is relevant to transformer inrush current as the unit H (Henry) is also denoted as the unit Amperes/Metre, which is directly proportional to the magnetisation current. This means that as the voltage increases and decreases on the hysteresis loop, so does the magnetisation current.

The saturation curve can also be described by magnetic flux and magnetising current, as represented in Figure 8.

The current increases substantially as the voltage begins to enter the saturation region. This is known as the inrush current and occurs once almost all of the dipole molecules in the ferromagnetic transformer core are aligned.

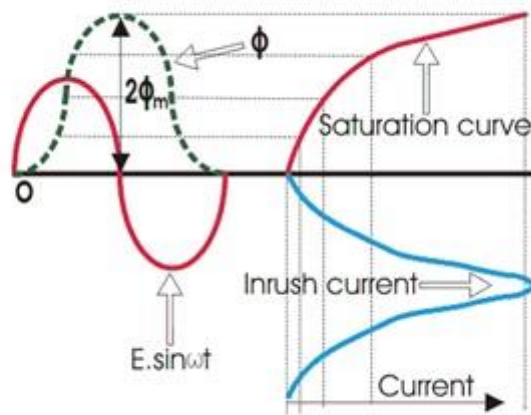

Figure 8: Inrush Current vs Saturation Curve vs Applied Voltage¹⁰

Inrush current is also dependant on the angle at which the voltage waveform is applied on the transformer. An equation which explains this concept can be derived;

Given that the resulting EMF (E) when a voltage is applied to a coil acts in the opposite direction to the applied voltage such that;

$$E = -V$$

Thus;

$$E = -V_{Max} \cos(\omega t + \alpha) \tag{1}$$

Where $\alpha = \theta + \frac{\pi}{2}$, this is due to the EMF leading the Applied Voltage by 90 degrees.

E is also given by Faradays Law;

$$E = -N_1 \left(\frac{d\phi}{dt} \right) \tag{2}$$

Equating these two equations gives;

$$-N_1 \left(\frac{d\phi}{dt} \right) = -V_{Max} \cos(\omega t + \alpha)$$

$$\frac{d\phi}{dt} = \frac{V_{Max}}{N_1} \cos(\omega t + \alpha) \tag{3}$$

¹⁰ Source - <https://www.electrical4u.com/magnetizing-inrush-current-in-power-transformer/>

Integrating this equation will give an equation for the flux value;

$$\varphi = \frac{V_{Max}}{N_1} \int \cos(\omega t + \alpha) * dt$$

$$\therefore \varphi = \frac{V_{Max}}{N_1} * \sin(\omega t + \alpha) + C \quad (4)$$

C is considered to be the formation of Asymmetric Flux during energisation of the transformer. It is described by the 'doubling effect' and also includes the residual flux previously discussed in this document. As flux cannot instantaneously rise to its peak value, it starts from zero and reaches 1pu after ¼ cycle of voltage and continues to increase until it becomes 2pu at ½ cycle after switching (Abhilash 2016).

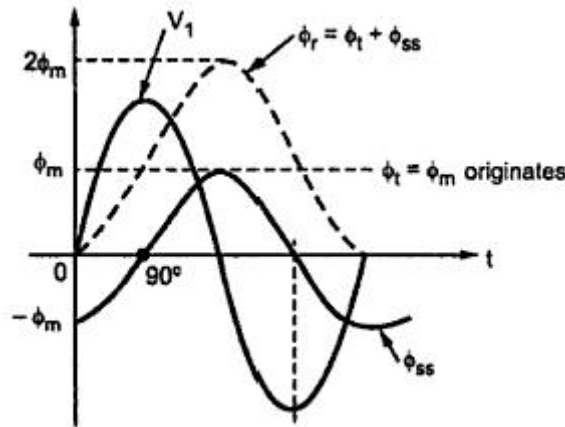

Figure 9: Doubling Effect in a Transformer (Your Electrical Home 2013)

The asymmetric flux can be expressed as;

$$\varphi_{residual} + \varphi_{Max} \sin \alpha$$

The doubling effect is only applicable to transient periods and the maximum core flux will exponentially return to its steady state maximum value as the system transitions into steady state.

Referring to Equation 4, it should be noted that there is a relationship such that;

$$\varphi_{Max} = \frac{V_{Max}}{N_1} \quad (5)$$

$$\therefore \varphi = \varphi_{Max} \sin(\omega t + \alpha) + \varphi_{residual} + \varphi_{Max} \sin \alpha \quad (6)$$

This can now be considered as the equation for flux. From Equation 6, it can be shown that the switching angle of voltage waveform has just as much of an effect on the transformer core flux as the residual flux. If a switching angle of 0 degrees is considered with a residual flux of 0 Wb;

$$\varphi = \varphi_{Max} \sin\left(\omega t + \frac{\pi}{2}\right) + 0 + \varphi_{Max} \sin\left(\frac{\pi}{2}\right)$$

$$\varphi = \varphi_{Max} \cos(\omega t) + \varphi_{Max}$$

$$\varphi = 2 * \varphi_{Max}$$

As discussed previously, this is due to the doubling effect. It can also be shown that if a switching angle 90 degrees ($\frac{\pi}{2}$) is considered with a residual flux of 0 Wb, then;

$$\varphi = \varphi_{Max} \sin(\omega t + 0) + 0 + \varphi_{Max} \sin(0)$$

$$\varphi = \varphi_{Max} \sin(\omega t)$$

$$\varphi = \varphi_{Max}$$

By switching the voltage at 90 degrees, the doubling effect is completely eliminated, and as a result, the minimal transient inrush current is drawn.

Therefore, it can be summarised from this information that the transformer inrush current is also significantly affected by the switching angle of the applied voltage.

The transient inrush current of the transformer also features a large DC Component; this can be noted through analysis using Fourier series techniques on the inrush current. Due to the DC transient properties of inductors:

$$\text{Inductor Time Constant } (\tau = \frac{L}{R}),$$

L = Inductance of Line and of Inductor, and

R = Resistance of Winding and Source;

This means that source reactance and resistance also play a major role in the decay of the transient inrush current. A higher source resistance will mean a faster decay rate ($I = I_0 e^{-\frac{t}{L}}$) where increases in R will decrease the duration of the transient current and slightly decrease the initial magnitude of the transient current as well. It should be noted that the resistance and reactance are considered to change in a power system between the subtransient, transient and steady states periods, thus the time constant for the rate of decay of the transient current is also considered to change between these periods.

Annex B

Normative

Numerical Method

The numerical method detailed here can be used to gain a brief understanding of the maximum current a three-phase system might experience during the inrush period, as well as the maximum voltage dip.

$$I_{first-peak} = \frac{V_m}{\sqrt{R^2 + (\omega L_{air-core})^2}} \left(\frac{B_r - B_s}{B_n} + \cos\theta + 1 \right)$$

The formula above is an early analytical calculation used to predict the first peak of inrush current.

Where:

V_m is the magnitude of the applied voltage

ω is the angular frequency

θ is the initial phase angle of the voltage source

R is the series resistance

$L_{air-core}$ is the air-core inductance of the energised winding

B_r and B_s are the Residual Flux Density (flux density is also depicted by Lambda often in literature)

B_n is the peak nominal flux density.

Using this formula with regards to the equivalent transformer model connected to a transmission line, the maximum voltage dip can be calculated.

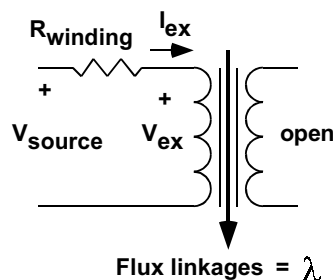

Figure 10: Approximate Transformer Model

Based on Figure 10, if an additional resistance is considered (R_{Source}) which would include the resistance of the connected transmission network, the voltage dip would be equal to:

$$V_{source-dip} = \frac{V_{source} - I_{first-peak} * (R_{source} + R_{winding})}{V_{source}}$$

This would give maximum percentage voltage dip.

A time-based equation can also be developed from the above calculation methodology.

This can be developed to create a time dependant equation that can be used to model the transformer inrush current waveform.

$$i_{peaks}(t) = \frac{\sqrt{2}V_m}{\sqrt{R^2 + (\omega L_{air-core})^2}} \cdot \left(\sin(\omega t - \phi) - e^{-\frac{R}{L_{air-core}}(t - \frac{\theta_{sat}}{\omega})} \cdot \sin(\theta_{sat} - \phi) \right)$$

Where:

$$\theta_{sat} = \cos^{-1} \left(\frac{B_s - B_n - B_r}{B_n} \right)$$

$$\phi = \tan^{-1} \left(\omega * \frac{L_{air-core}}{R} + \theta \right) = \text{phase angle between voltage and current vectors}$$

θ is the phase voltage angle

Applying this formula to the previous voltage dip percentage equation would give:

$$V_{source-dip}(t) = \frac{V_{source}(t) - I_{peaks}(t) * (R_{source} + R_{winding})}{V_{source}(t)}$$

Where:

V_{Source} is the sinusoidal voltage source

This method can be applied to each individual phase of a three-phase transformer to calculate the overall voltage dip on each phase. It should be noted that this is an estimation method only and does not give an accurate representation of the true inrush current in a three-phase system nor does it consider wider system effects.

Annex C

Informative

Transformer Model Validation Guideline

This guideline describes the methodology that can be used to validate an EMT transformer saturation model. The methodology focuses on determining a reasonable value for the slope of the magnetisation curve at extreme saturation as this parameter has the most influence on inrush current magnitude. This parameter is entered directly into PSCAD as the air core reactance in the general transformer model when using the Classical Approach or can be used to check the slope of the V-I curve values in the deep saturation region when other modelling approaches are used.

The following methodology assumes that detailed design data for the transformer (e.g. turns numbers, core geometry) is unavailable and that the air core inductance cannot be accurately estimated using analytical formulae. This guideline shall be used when determining the assumptions to present a transformer energisation except where appropriate alternative peer reviewed referenced sources are available.

C.1 Model Validation from Inrush Current Measurements

The magnitude and duration of the transient inrush current experienced when energising a transformer depends on the following factors:

- the point on the voltage wave at the instant the transformer circuit is energised,
- the impedance of the circuit supplying the transformer,
- the non-linear saturation characteristics of the transformer core, and
- the value and sign of the residual flux linkage in the transformer core.

The first two factors in this list depend on the characteristics of the supply to which the transformer is connected and the switching arrangements. The remaining factors are dependent upon the characteristics of the magnetic circuit of the transformer core and the history of the core, i.e. the instant at which the transformer was previously demagnetised.

The validation of a model with a single inrush current measurement may be inadequate if more than one of the factors from the list above is unknown. Table 4 lists the assumptions and challenges that may be associated with verification of each of the above factors.

Table 3: List of Assumptions and Challenges Associated with Verification of Factors Affecting Inrush Currents

Inrush current factor	Verification assumptions and challenges
Point on wave	<ul style="list-style-type: none"> • Cannot be calculated precisely using inrush measurements, unless controlled switching is used • Can be estimated from inrush measurements with reasonable accuracy • Small estimation error will not be significant when tuning saturation characteristics
Fault level	<ul style="list-style-type: none"> • Can be estimated with reasonable accuracy using system conditions (e.g. published fault levels or power system modelling)

Standard for Plant Energisation (STNW1179)

Inrush current factor	Verification assumptions and challenges
	<ul style="list-style-type: none"> • Important for tuning a model to achieve similar voltage dip during switching and inrush decay • For very weak systems (e.g. SCR = 3 or lower based on transformer rating), maximum inrush current will be largely determined by the system fault level and will be less sensitive to saturation characteristics, making verification of these characteristics using inrush measurements more difficult but also much less critical
Saturation characteristics	<ul style="list-style-type: none"> • Critical parameter affecting inrush current is the slope of the magnetisation curve in the saturated region, i.e. the air core inductance • Cannot be directly measured and unlikely to have sufficient data for calculation • Initial estimates for parameters such as reactances should be based on published guidelines, such as CIGRE Technical Brochure 039¹¹.
Residual flux	<ul style="list-style-type: none"> • Cannot be directly measured and hard to predict with modelling due to typical lack of data on core hysteretic characteristics • Worst case typically assumed to be 0.6 – 0.8 p.u rated flux with distribution 0.6/-0.3/-0.3 p.u in three phases • Demagnetising a transformer so there is zero residual flux prior to switching is possible and can limit the level of saturation and corresponding inrush current during energisation • For all practical transformer designs, saturation and the drawing of inrush current will always occur at energisation, even if the residual flux is zero; note that with zero residual flux, the maximum inrush current will be relatively insensitive to the point on the voltage wave at which energisation occurs • With non-zero residual flux, the level of saturation and inrush current magnitude is sensitive to the point on the voltage wave at which energisation occurs and can range from zero to the worst-case inrush current

The plots shown in Figure 11 demonstrate several of the points made concerning inrush current in Table 3. The data for these plots was generated in PSCAD using a general transformer model with a Dyn11 winding type and with the residual flux set to zero. For the standard core design, the default PSCAD parameters were used as demonstrated in Table 4. The transformer was energised against an ideal zero-impedance source for the core comparison plots, while for the “strong system” and “weak system” plots a non-zero source impedance was introduced with an X/R ratio of 5 and short circuit ratios of 10 and 3 respectively. The point on the voltage wave at which energisation occurred was simply set to zero in all of the simulations used to generate Figure 11 as the variation of maximum inrush across all three phases given zero residual flux is known to be relatively insensitive to this parameter.

Table 4: Model Validation Parameters

Scenario	Parameter	Value
Standard Core Design	Leakage Impedance	0.1 p.u.
	Knee-point voltage of the core	1.17 p.u.
	Magnetising current	1%
Improved Core Design	Knee-point voltage of the core	1.3 p.u.
Poor Core Design	Knee-point voltage of the core	1.1 p.u.
Strong System	X/R ratio	5
	Short Circuit Ratio	10

¹¹ CIGRE, “Guidelines for representation of network elements when calculating transients”, Technical Brochure 039, WG 33.02, 1990.

Scenario	Parameter	Value
Weak System	X/R ratio	5
	Short Circuit Ratio	3

The size of the transformer was set to 15 MVA and the primary and secondary winding voltages were set to 66 kV and 33 kV. Repeated simulations revealed however that these last three parameters had no effect on the relationship between per-unit maximum inrush current and per-unit air core reactance when the residual flux is set to zero.

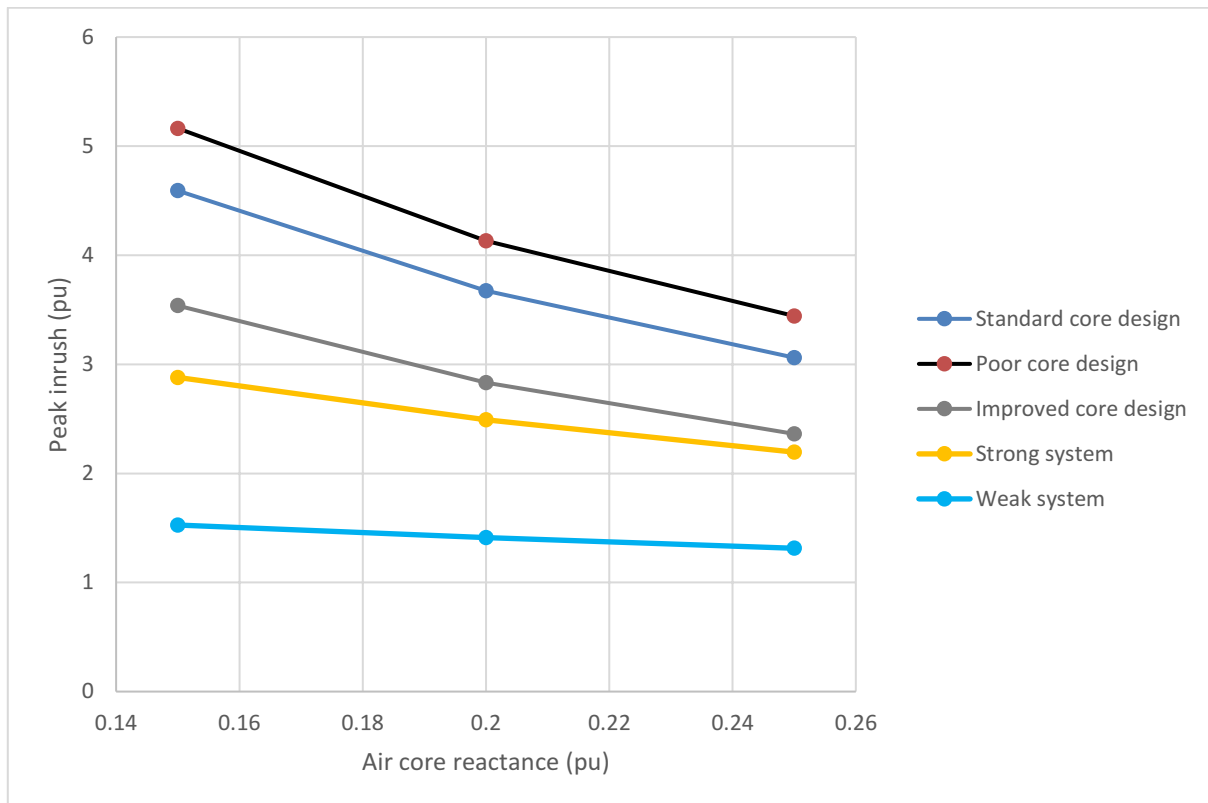

Figure 11: Sensitivity of Maximum Inrush Current to Saturation Characteristics for Dyn11 Transformer and Zero Residual Flux

It is clear from Figure 11 that the maximum inrush current with zero residual flux is sensitive to the air core reactance in general, but that this sensitivity begins to decrease as the level of system strength becomes weaker. It is also clear that variations in knee-point voltage will also influence the maximum inrush current to some degree.

C.2 Example Model Validation

The following example compares measured and simulation results for a 40 MVA autotransformer modelled using the Classical Approach. The air core reactance was calculated from $\Phi-I_{peak}$ (fluxlinked-current) values derived from a theoretical $V_{rms}-I_{rms}$ saturation characteristic provided by the manufacturer and was shown to be approximately four times the leakage reactance of the transformer. This falls at the lower end of the CIGRE range for air core reactance values for autotransformers. The maximum inrush currents are plotted as a function of switching angle when energised against an ideal source for maximum and zero residual flux linkage conditions in Figure

12 and Figure 13. Figure 13 demonstrates the insensitivity of the maximum inrush current to the point on the voltage wave during energisation when the residual flux is zero.

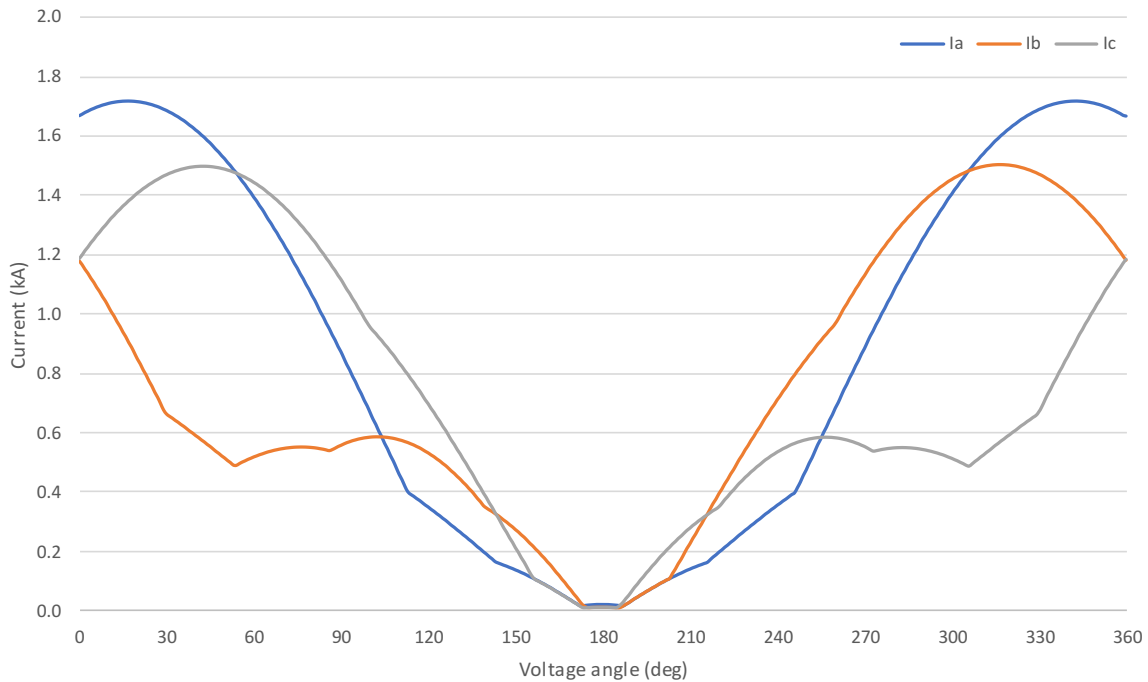

Figure 12: Transformer Phase Currents as a Function of Switching Angle when Energised Against an Ideal 66kV Source with the Worst Residual Flux

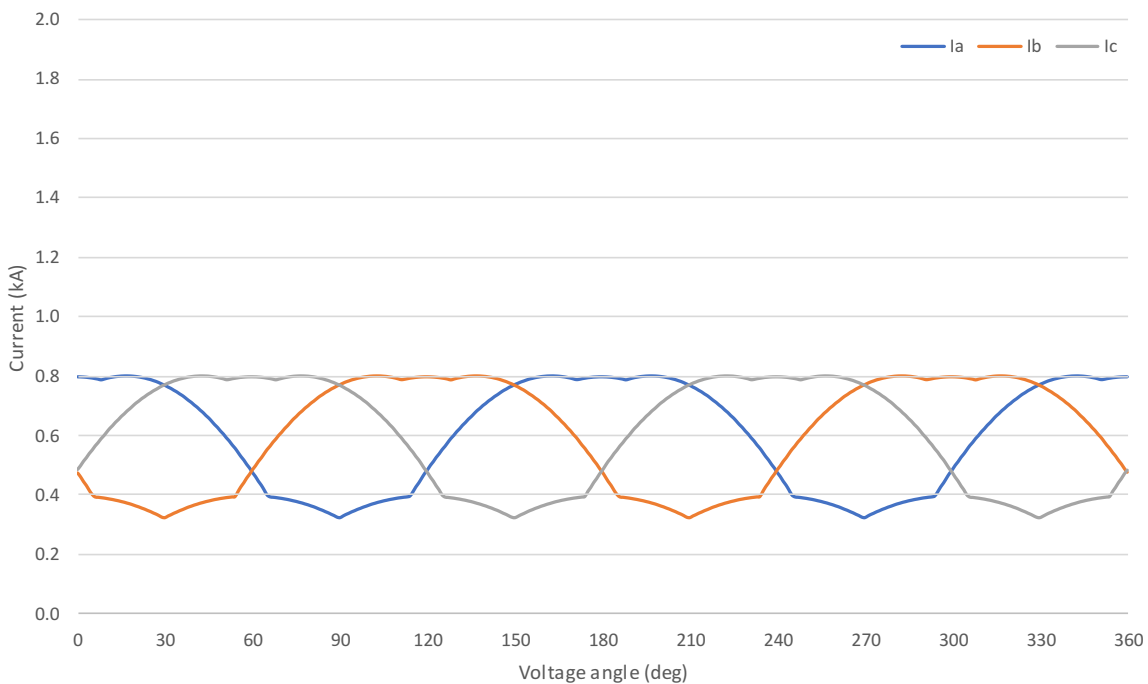

Figure 13: Transformer Phase Currents as a Function of Switching Angle when Energised Against an Ideal 66kV Source with the Zero Residual Flux

The inrush current measured in the field when the autotransformer was energised with zero residual flux is shown in Figure 14. It can be observed that due to the finite source impedance, the maximum

inrush current reduces from the simulated value of 800 A to about 300 A. Note that the inrush current is not simultaneous with the estimated angle on the voltage waveform at which energisation occurs; the increase in the line current due to saturation is delayed as the flux-linkage (which determines the magnetising current) must build up from zero based on the integral of the voltage.

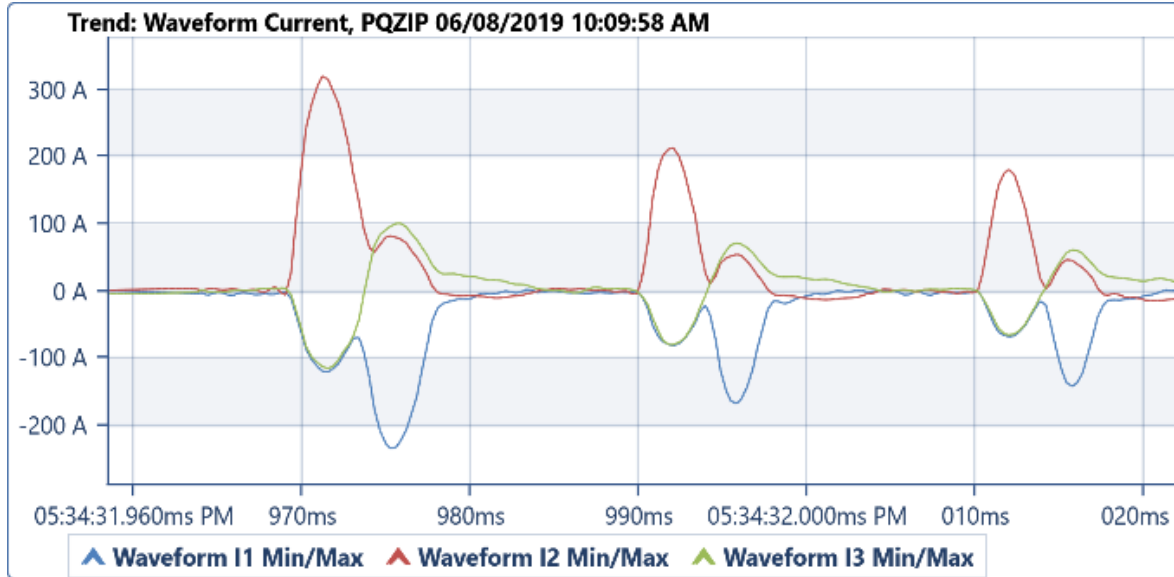

Figure 14: Measured 66kV Line Current

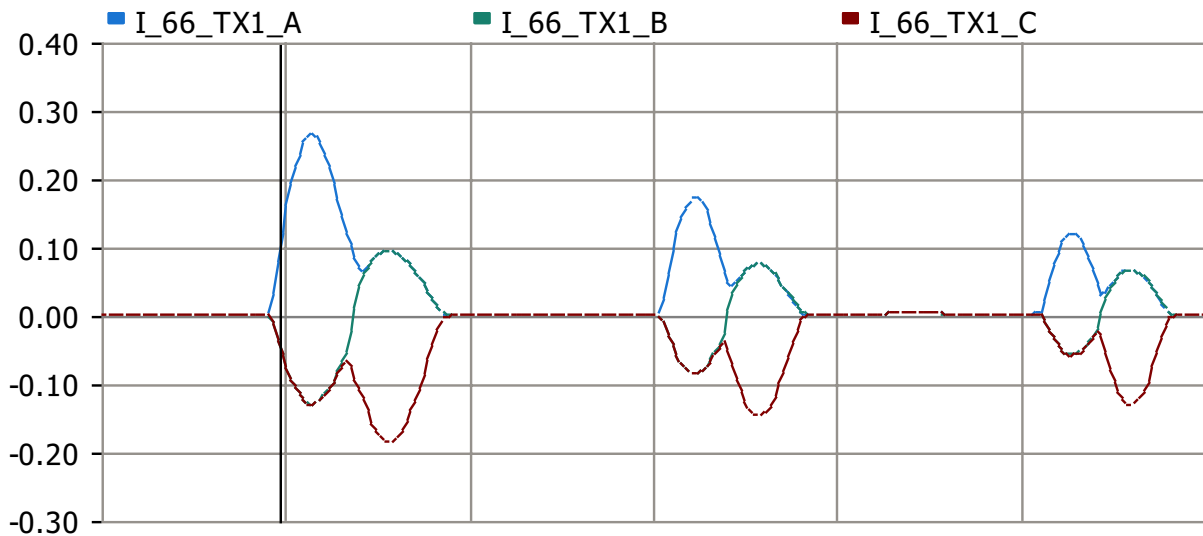

Figure 15: Simulated 66kV Line Current

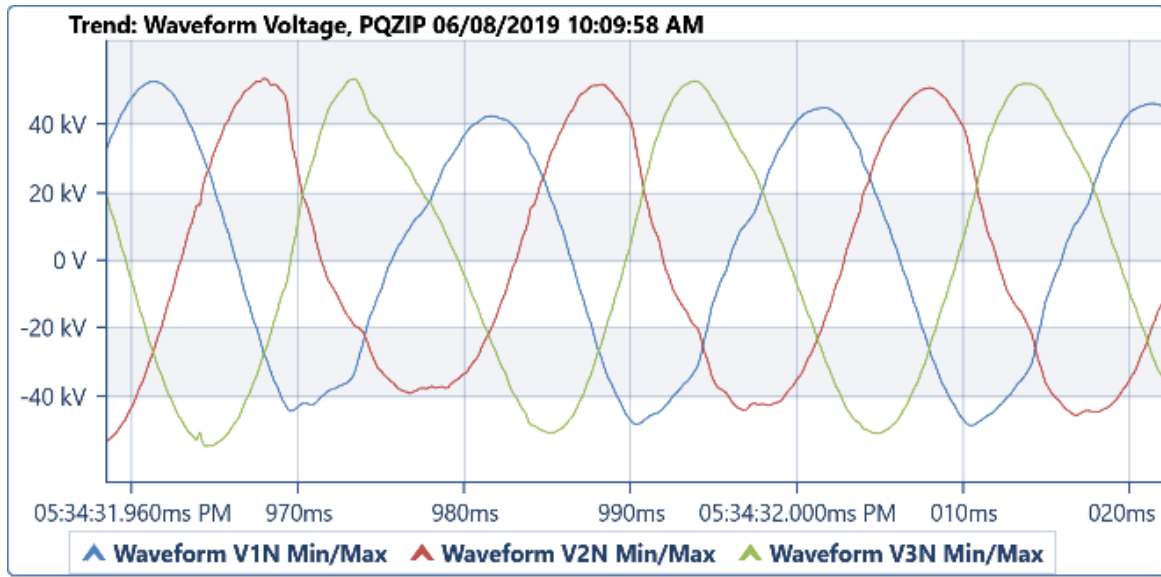

Figure 16: Measured Instantaneous Line to Neutral Voltages

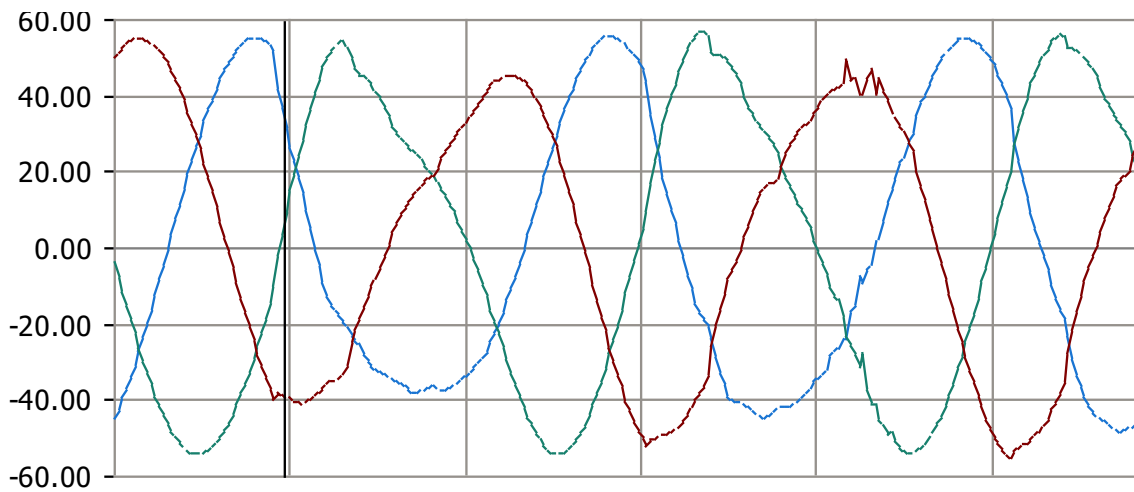

Figure 17: Simulated Instantaneous Line to Neutral Voltages

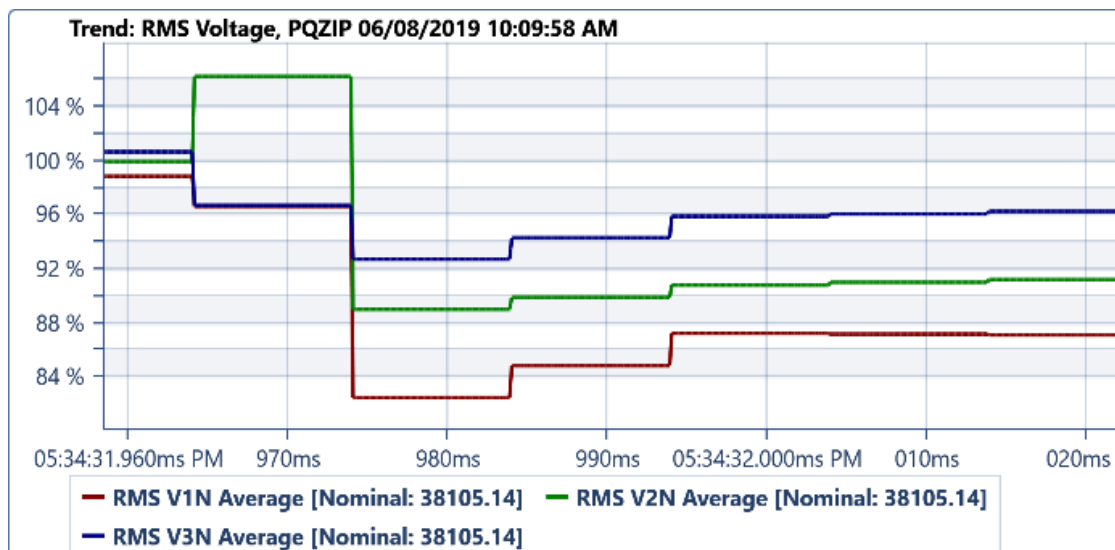

Figure 18: Measured 66kV RMS Voltages

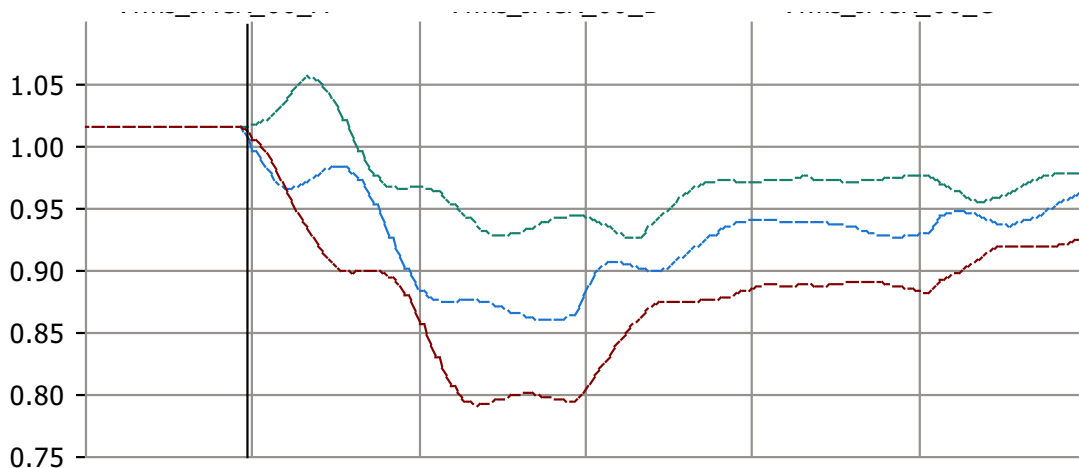

Figure 19: Simulated 66kV RMS Voltages

The inrush current and line to neutral voltages that were calculated using the provided PSCAD model with the residual flux set to zero are shown in Figure 14 and Figure 16. The shape of the line currents shows a good match between the PSCAD model and the field test results, although the maximum and minimum currents calculated using the PSCAD model are approximately 20% lower. This difference is most likely attributable to error in the modelled characteristics of the supply network, specifically the source impedance and X/R ratio. Inspection of the rms line voltages also supports this as the minimum voltages generated by the PSCAD model are slightly lower than the field test results, despite the line currents also being lower. A lower source impedance (higher fault level or stronger system) in the PSCAD model could be expected to result in a higher inrush current and a higher minimum voltage. The model was therefore deemed to be a reasonable representation of the transformer based on these results and would be suitable for studies investigating the impact of residual flux and point on wave switching to determine the worst-case inrush current and corresponding voltage dips on the network.

C.3 Consideration of Sympathetic Inrush Current

A sympathetic inrush current may be drawn by other online transformers when a transformer is energised. This occurs when the dc component of current drawn by the transformer being energised flows through the resistive component of the system impedance, which causes a dc component of voltage. This dc voltage is seen by all other online transformers and if it is significant, it can cause an offset in their flux linkage which drives the transformers into saturation and their magnetising currents increase.

As the resistive component of the impedance supplying smaller transformers (e.g., collector or distribution) is often very low, this phenomenon is seldom expected to significantly affect the model validation results for such network transformers (i.e. other online collector/distribution transformers and the main grid connected power transformer(s) are unlikely to experience significant saturation due to sympathetic inrush when energising collector transformers).

Nevertheless, where possible, measurements should be taken of the line currents for other online transformers during testing to confirm the levels of sympathetic inrush current and model validation and plant energisation simulations should always include saturation models for all other online transformers that form part of the generating system or nearby distribution network.

C.4 Model Validation Flowchart

A flowchart that can be followed when validating EMT transformer saturation models is shown below in Figure 20. Note that the approximate values quoted for the air core reactance by CIGRE are a useful guide, but that they may be ignored if the model exhibits good agreement with inrush currents measured in the field after demagnetisation and the resulting air core reactance meets $X_L < X_{AIR} \leq 4 \cdot X_L$. That is, it should at least be ensured that the air core reactance is equal to or greater than the cumulative leakage reactance of the transformer, since values below the leakage reactance could be proven erroneous using simple physics-based reasoning.

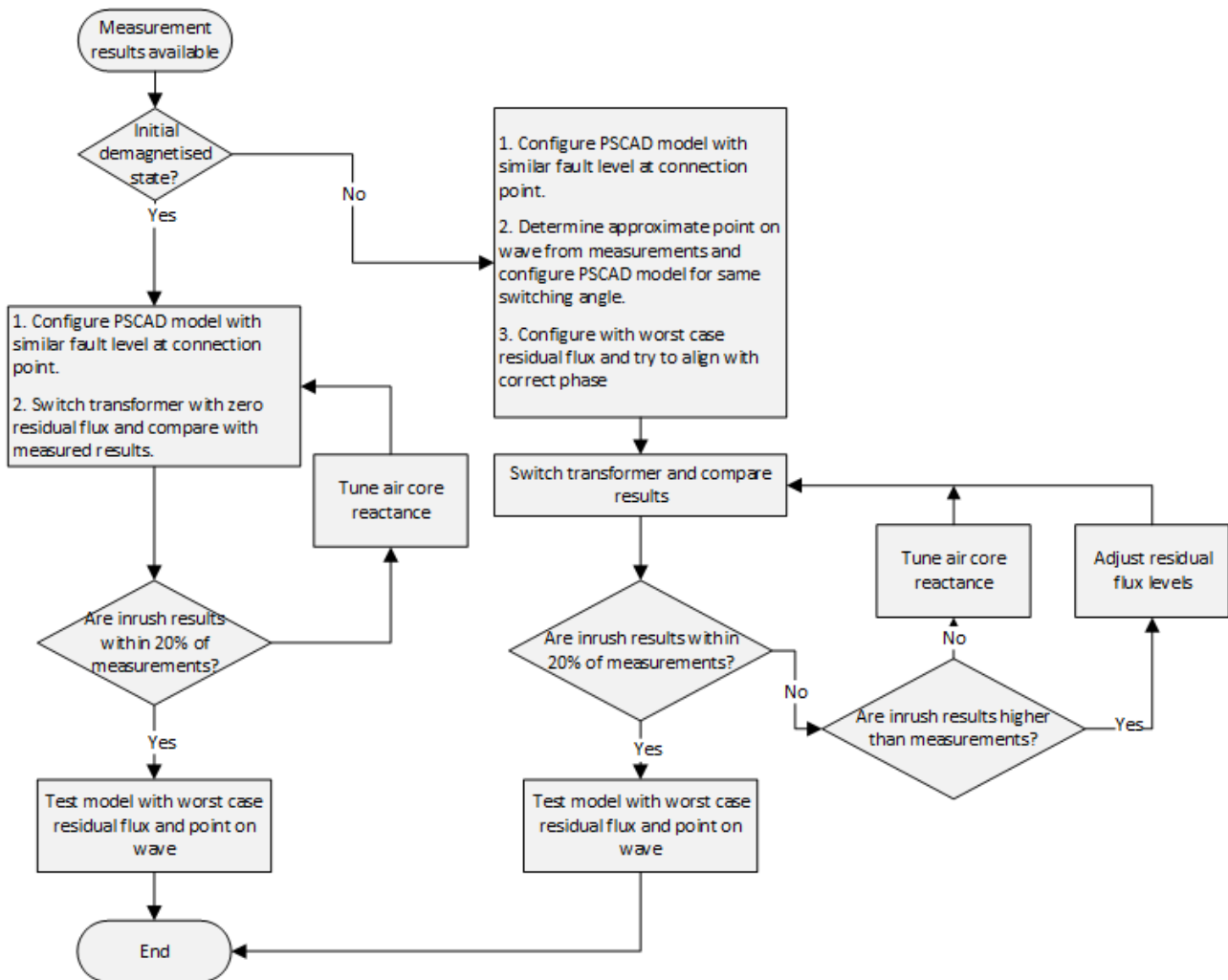

Figure 20: Model Validation Flowchart

C.5 Concluding Note

Care should be taken when validating a UMEC transformer model in PSCAD. If the saturation characteristic is to be tuned to get a better match to measurement data, the V-I rms data in the UMEC model should first be converted to Φ -I_{peak} (fluxlinked-current) values to confirm the air core inductance in the deep saturation region of the curve. The slope of this value can then be modified (considering the typical range discussed above) before converting the Φ -I_{peak} values back to V-I rms data for entry into the model.